

Odgovori na vaša vprašanja v zvezi z Danfoss ogrevalno tehniko so vam na voljo pri:

Tehnična podpora: **01 582 04 33**
Prodaja: **051 376 368, 040 388 618**

Naročanje, dobava: **01 888 86 68**

Pri konfiguraciji in zagonih Danfossovih toplotnih postaj vam bo pomagal naš sistemski integrator:

Petrol d.d. Energetske rešitve

Blaž Koren
Pot na Lisice 7, 4260 Bled

Telefon: **04 575 30 05**

Mobilni: **051 371 665**

Pri nastavitvah Danfoss regulacijske opreme vam bodo pomagali naši pooblašteni servisni zastopniki:

DM d.o.o.

Luka Malavašič
Cesta v Lipovce 33, 1358 Log pri Brezovici
Telefon: **01 756 60 96**
Mobilni: **051 644 599**
Telefax: **01 756 60 96**

Montaža in servis naprav

Jožef Ficko s.p.
Gornji Črnici 3, 9261 Cankova
Telefon: **02 540 90 45**
Mobilni: **031 612 628**
Telefax: **02 540 90 44**

M-STIS d.o.o.

Marko Zoroja
Erjavčeva 17, 5000 Nova Gorica
Telefon: **05 302 45 01**
Mobilni: **041 633 345**
Telefax: **05 333 08 53**

EMV d.o.o.

Andrej Jerman
Trpinčeva ulica 39, 1000 Ljubljana
Telefon: **01 546 50 78**
Mobilni: **041 636 668**
Telefax: **01 546 50 79**

Blažun d.o.o.

Niko Blažun
Mariborska cesta 14, 3000 Celje
Telefon: **03 492 35 50**
Mobilni: **041 624 254**
Telefax: **03 492 35 52**

SMOG

Franc Rupnik s.p.
Godovič 96, 5275 Godovič
Telefon: **05 374 70 28**
Mobilni: **041 616 233, 050 616 233**
Telefax: **05 374 70 28**

Zvone Kosirnik s.p.

Zvone Kosirnik
Selo pri Ihanu 36A, 1230 Domžale
Telefon: **01 729 22 44**
Mobilni: **041 367 233**
Telefax: **01 729 22 43**

Jaušovec Roman s.p.

Roman Jaušovec
Podkraj 13e, 3310 Žalec
Telefon: **03 891 80 10**
Mobilni: **041 640 198**
Telefax: **03 588 86 50**

SRM Pečar Miran s.p.

Miran Pečar
Ulica 15. maja 10a, 6000 Koper
Telefon: **05 631 20 02**
Mobilni: **041 625 338**
Telefax: **05 631 20 03**

VENMA Albert Mrak s.p.

Albert Mrak
Konca Vas 8, 1332 Stara cerkev
Telefon: **01 895 08 90**
Mobilni: **041 617 506, 041 636 463**
Telefax: **01 895 08 91**

SONDA - Montaža, Servis

Sonc Damjan s.p.
Cesta za gradom 4a, 1433 Radeče
Telefon: **03 568 52 44**
Mobilni: **041 713 244**
Telefax: **03 568 75 81**

Elektro servis

Janez Debenc s.p.
Hinje 4, 8297 Šentjanž
Telefon: **07 818 49 07, 492 24 26**
Mobilni: **041 506 285**
Telefax: **07 492 24 26**

E.I.I.S.A.

Slavko Ranfl s.p.
Paradiž 10b, 2282 Cirkulane
Telefon: **02 761 24 11**
Mobilni: **041 462 427**
Telefax: **02 761 24 11**

Domen Ivanc s.p.

Domen Ivanc
Vetrišče 17, 5000 Nova Gorica
Telefon: **05 302 71 82**
Mobilni: **041 625 073**
Telefax: **05 302 71 82**

Elektro servis instalacije

Kuzma Slavko s.p.
Čopova 12, 8340 Črnomelj
Telefon: **07 354 02 53**
Mobilni: **031 652 017**
Telefax: **07 354 02 53**

KlimaGEP d.o.o.

Cesta k Tamu 19, 2000 Maribor
Telefon: **02 460 51 00, 460 51 01**
Mobilni: **041 792 579**
Telefax: **02 460 51 06**

Elektroinstalacije

Baruca Stanko s.p.
Dolga reber 30b, 6000 Koper
Telefon: **05 628 25 23**
Mobilni: **041 634 469**
Telefax: **05 628 25 23**

Detekcija napak in popravila električnih grelnih preprog:

ETIK, d.o.o.

e-mail: info@etik.si
Tržaška cesta 215, 1000 Ljubljana
Telefon: **01 256 79 91**
Mobilni:
Telefax: **01 256 50 16**

TERABIT D.O.O.

e-mail: info@terabit.si
Zagrebska cesta 40A, 2000 Maribor
Telefon: **02 330 03 82**
Mobilni: **051 314 199**
Telefax: **02 330 08 85**

Lotani	05M-1, 06H+, 06L-1, 06H-1	3-6	DN 20
	XB 37L-1, 37M-1, 37H-1	8-10	DN 25
	XB 12L-1, 12M-1, 12H-1	11-13	DN 32
	XB 51L-1, 52M-1, 59M-1 XB 61L-1, 61M-1, 61H-1	14-19	DN 50
	66L-1, 66H-1	20-21	DN 65
	XB 70L-1, 70M-1, 70H-1	22-24	DN 65/100
	XB 12L-2, 12M-2, 12H-2	25-27	DN 32
	XB 51L-2, 52M-2	28-29	DN 50
	Vijačeni		
Vijačeni prenosniki toplote po povpraševanju			

Abecedno kazalo

Proizvod	Stran	Proizvod	Stran	Proizvod	Stran
Lotani prenosniki toplote z enim prehodom					
XB 05M	4				
XB 06H+	5				
XB 06L-1	6				
XB 06H-1	7				
XB 37L-1	8				
XB 37M-1	9				
XB 37H-1	10				
XB 12L-1	11				
XB 12M-1	12				
XB 12H-1	13				
XB 51L-1	14				
XB 52M-1	15				
XB 59M-1	16				
XB 61L-1	17				
XB 61M-1	18				
XB 61H-1	19				
XB 66L-1	20				
XB 66H-1	21				
XB 70L-1	22				
XB 70M-1	23				
XB 70H-1	24				
Lotani prenosniki toplote z dvema prehodoma					
XB 12L-2	25				
XB 12M-2	26				
XB 12H-2	27				
XB 51L-2	28				
XB 52M-2	29				

Kazalo po kodah se nahaja na straneh 30 do 31.

Prenosniki toplote

DN 20

Koda	Tip	Masa [kg]	Dolž. (F+E) [mm]	Priključek		Cena EUR
				vrsta	dimenzija	

Lotani prenosnik toplote z enim prehodom XB, tip 05M

XB 05M

material plošč nerjaveče jeklo 1.4404, lotani z bakrom, PN25, primeren za obtočno in sanitarno vodo ter mešanice glikol/voda do 50% glikola, maks. temperatura medija 180°C, min. temperatura medija -10°C, pri temperaturah pod 2°C mora biti uporabljena mešanica glikola in vode.



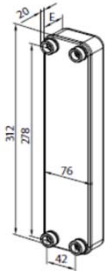

Dimenzije: horizontalna/vertikalna razdalja med priključki D/C=42/278mm, širina/višina B/A=76/312mm.

004B3556	XB 05M-1 10	2	39,9	zunanj cilindrični navoj ISO 228/1	G 3/4" A	104,00	
004B3557	XB 05M-1 16	2	47,0			115,00	
004B3558	XB 05M-1 20	2	51,8			135,00	
004B3559	XB 05M-1 26	2	58,9			163,00	
004B3560	XB 05M-1 30	2	63,7			182,00	
004B3561	XB 05M-1 36	3	70,8			200,00	
004B3562	XB 05M-1 40	3	75,6			212,00	
004B3563	XB 05M-1 50	3	87,5			243,00	
004B3564	XB 05M-1 60	4	99,4	284,00			
004B3565	XB 05M-1 70	4	111,3	323,00			

Dodatki

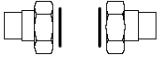
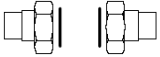
Koda	Tip, opis	Cena EUR
------	-----------	----------

Priključki

004B2945	© Set priključkov za lotanje G 3/4" A / 15mm, 2 priključka	36,70	
004B2946	© Set priključkov za lotanje G 3/4" A / 18mm, 2 priključka	34,70	
004B2944	Set varilnih priključkov G 3/4" A / DN20, 2 priključka	29,00	
004B2947	Set navojnih priključkov G 3/4" A / G 3/4 A, 2 priključka	50,00	
004B2953	Set navojnih priključkov G 3/4" A / G 1 A, 2 priključka	50,00	

Izolacije

Za prenosnike toplote XB 05M ni na razpolago tovarniško izdelane izolacije.

Prenosniki toplote

Koda	Tip	Masa [kg]	Dolž. (F+E) [mm]	Priključek		Cena EUR
				vrsta	dimenzija	

Lotani prenosnik toplote z enim prehodom XB, tip 06H+

XB 06H+

material plošč nerjaveče jeklo 1.4404, lotani z bakrom, PN25, primeren za obtočno in sanitarno vodo ter mešanice glikol/voda do 50% glikola, maks. temperatura medija 180°C, min. temperatura medija -10°C, pri temperaturah pod 2°C mora biti uporabljena mešanica glikola in vode.

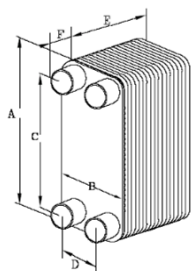

Dimenzije: horizontalna/vertikalna razdalja med priključki D/C=45/270mm, širina/višina B/A=95/320mm.

004B1206	© XB 06H+ 8	2	34,6	zunanj cilindrični navoj ISO 228/1	G 3/4" A	112,20	
004B1207	© XB 06H+ 10	2	36,5			118,00	
004B1209	© XB 06H+ 16	2	42,2			138,00	
004B1211	© XB 06H+ 20	2	46,0			157,00	
004B1212	© XB 06H+ 26	3	51,7			191,00	
004B1214	© XB 06H+ 30	3	55,5			213,00	
004B1216	© XB 06H+ 36	4	61,2			236,00	
004B1217	© XB 06H+ 40	4	65,0			249,00	
004B1219	© XB 06H+ 50	5	74,5			286,00	
004B1221	© XB 06H+ 60	5	84,0			333,00	
004B1222	© XB 06H+ 70	6	93,5			380,00	
004B1223	© XB 06H+ 80	7	103,0			426,00	

Dodatki

Koda	Tip, opis	Cena EUR
------	-----------	----------

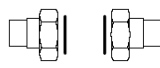
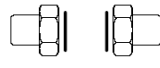
Priključki

004B2945	© Set priključkov za lotanje G 3/4" A / 15mm, 2 priključka	36,70	
004B2946	© Set priključkov za lotanje G 3/4" A / 18mm, 2 priključka	34,70	
004B2944	Set varilnih priključkov G 3/4" A / DN20, 2 priključka	29,00	
004B2947	Set navojnih priključkov G 3/4" A / G 3/4 A, 2 priključka	50,00	
004B2953	Set navojnih priključkov G 3/4" A / G 1 A, 2 priključka	50,00	

Montažna konzola

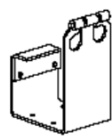
004B2948	Montažna konzola za XB 06	66,00	
----------	---------------------------	-------	---

Izolacije

T_{maks}=130°C, kratkotrajno do 160°C

004B1191	Izolacija za XB06H+ : 8 -> 36	92,00	
004B1192	Izolacija za XB06H+ : 40 -> 70	94,00	
004B1193	Izolacija za XB06H+ : 80	96,00	

Prenosniki toplote

DN 20

Koda	Tip	Masa [kg]	Dolž. (F+E) [mm]	Priključek		Cena EUR
				vrsta	dimenzija	

Lotani prenosnik toplote z enim preходом XB, tip 06L

XB 06L-1

material plošč nerjaveče jeklo 1.4404, lotani z bakrom, PN25, primeren za obtočno in sanitarno vodo ter mešanice glikol/voda do 50% glikola, maks. temperatura medija 180°C, min. temperatura medija -10°C, pri temperaturah pod 2°C mora biti uporabljena mešanica glikola in vode.

Dimenzije: horizontalna/vertikalna razdalja med priključki D/C=45/270mm, širina/višina B/A=95/320mm.

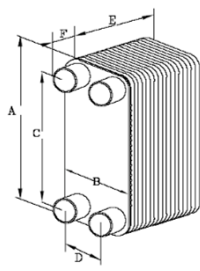
004B2024	© XB 06L-1 8	2	39,8	zunanji cilindrični navoj ISO 228/1	G 3/4" A	112,20	
004B2025	© XB 06L-1 10	2	43,0			118,00	
004B2026	XB 06L-1 16	2	52,6			138,00	
004B2027	XB 06L-1 20	3	59,0			157,00	
004B2028	© XB 06L-1 26	3	68,6			191,00	
004B2029	© XB 06L-1 30	4	75,0			213,00	
004B2030	© XB 06L-1 36	4	84,6			236,00	
004B2031	© XB 06L-1 40	4	91,0			249,00	
004B2032	© XB 06L-1 50	5	107,0			286,00	
004B2033	© XB 06L-1 60	6	123,0			333,00	
004B2034	© XB 06L-1 70	7	139,0	380,00			

Dodatki

Koda	Tip, opis	Cena EUR
------	-----------	----------

Priključki

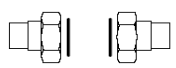
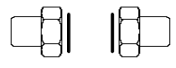
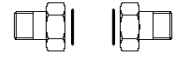
004B2945	© Set priključkov za lotanje G 3/4" A / 15mm, 2 priključka	36,70	
004B2946	© Set priključkov za lotanje G 3/4" A / 18mm, 2 priključka	34,70	
004B2944	Set varilnih priključkov G 3/4" A / DN20, 2 priključka	29,00	
004B2947	Set navojnih priključkov G 3/4" A / G 3/4 A, 2 priključka	50,00	
004B2953	Set navojnih priključkov G 3/4" A / G 1 A, 2 priključka	50,00	

Montažna konzola

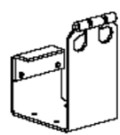
004B2948	Montažna konzola za XB 06	66,00	
----------	---------------------------	-------	---

Izolacije

T_{maks} = 130°C, kratkotrajno do 160°C

004B1191	Izolacija za XB06-1 : 8 -> 26	92,00	
004B1192	Izolacija za XB06-1 : 30 -> 48	94,00	
004B1193	Izolacija za XB06-1 : 50 -> 70	96,00	

Prenosniki toplote

Koda	Tip	Masa [kg]	Dolž. (F+E) [mm]	Priključek		Cena EUR	
				vrsta	dimenzija		

Lotani prenosnik toplote z enim preходом XB, tip 06H

XB 06H-1

material plošč nerjaveče jeklo 1.4404, lotani z bakrom, PN25, primeren za obtočno in sanitarno vodo ter mešanice glikol/voda do 50% glikola, maks. temperatura medija 180°C, min. temperatura medija -10°C, pri temperaturah pod 2°C mora biti uporabljena mešanica glikola in vode.

Dimenzije: horizontalna/vertikalna razdalja med priključki D/C=45/270mm, širina/višina B/A=95/320mm.

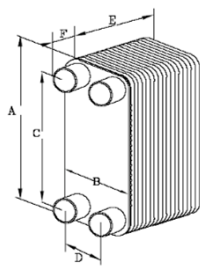
004B2036	© XB 06H-1 8	2	37,0	zunanji cilindrični navoj ISO 228/1	G 3/4" A	112,20	
004B2037	XB 06H-1 10	2	39,5			118,00	
004B2038	XB 06H-1 16	2	47,0			138,00	
004B2039	XB 06H-1 20	3	52,0			157,00	
004B2041	XB 06H-1 26	3	59,5			191,00	
004B2042	XB 06H-1 30	4	64,5			213,00	
004B2043	XB 06H-1 36	4	72,0			236,00	
004B2044	XB 06H-1 40	4	77,0			249,00	
004B2046	© XB 06H-1 50	5	89,5			286,00	
004B2047	© XB 06H-1 60	6	102,0			333,00	
004B2048	© XB 06H-1 70	7	114,5	380,00			

Dodatki

Koda	Tip, opis	Cena EUR	
------	-----------	----------	--

Priključki

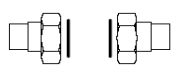
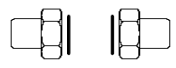
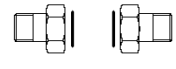
004B2945	© Set priključkov za lotanje G 3/4" A / 15mm, 2 priključka	36,70	
004B2946	© Set priključkov za lotanje G 3/4" A / 18mm, 2 priključka	34,70	
004B2944	Set varilnih priključkov G 3/4" A / DN20, 2 priključka	29,00	
004B2947	Set navojnih priključkov G 3/4" A / G 3/4 A, 2 priključka	50,00	
004B2953	Set navojnih priključkov G 3/4" A / G 1 A, 2 priključka	50,00	

Montažna konzola

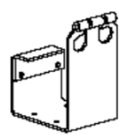
004B2948	Montažna konzola za XB 06	66,00	
----------	---------------------------	-------	---

Izolacije

T_{maks}=130°C, kratkotrajno do 160°C

004B1191	Izolacija za XB06-1 : 8 -> 26	92,00	
004B1192	Izolacija za XB06-1 : 30 -> 48	94,00	
004B1193	Izolacija za XB06-1 : 50 -> 70	96,00	

Prenosniki toplote

Koda	Tip	Masa [kg]	Dolž. (F+E) [mm]	Priključek		Cena EUR
				vrsta	dimenzija	

Lotani prenosnik toplote z enim prehodom XB, tip 37L

XB 37L-1

material plošč nerjaveče jeklo 1.4404, lotani z bakrom, PN25, primeren za obtočno in sanitarno vodo ter mešanice glikol/voda do 50% glikola, maks. temperatura medija 180°C, min. temperatura medija -10°C, pri temperaturah pod 2°C mora biti uporabljena mešanica glikola in vode.

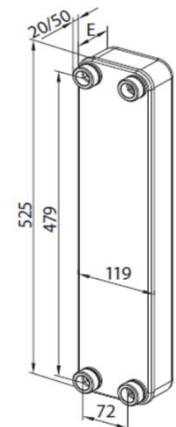

Dimenzije: horizontalna/vertikalna razdalja med priključki D/C=72/479mm, širina/višina B/A=119/525mm.

004H7270	XB 37L-1 10	4	52,1	zunanj cilindrični navoj ISO 228/1	G 1" A		228,00
004H7271	XB 37L-1 16	5	65,4				262,00
004H7272	XB 37L-1 20	6	74,2				284,00
004H7273	XB 37L-1 26	7	87,5				317,00
004H7274	XB 37L-1 30	8	96,3				340,00
004H7275	XB 37L-1 36	9	109,6				371,00
004H7276	XB 37L-1 40	9	118,4				395,00
004H7277	XB 37L-1 50	11	140,5				451,00
004H7278	XB 37L-1 60	12	162,6				506,00
004H7279	XB 37L-1 70	14	184,7				561,00
004H7280	XB 37L-1 80	16	206,8				616,00
004H7281	XB 37L-1 90	17	228,9				672,00
004H7282	XB 37L-1 100	19	251,0				727,00
004H7283	XB 37L-1 110	20	273,1				783,00
004H7284	XB 37L-1 120	22	295,2	838,00			

Dodatki

Koda	Tip, opis	Cena EUR
------	-----------	----------

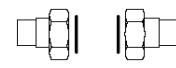
Priključki

004B2904	⊙ Set priključkov za lotanje G 1" A / 15mm, 2 priključka	37,00	
004B2905	⊙ Set priključkov za lotanje G 1" A / 18mm, 2 priključka	35,00	
004B2906	Set priključkov za lotanje G 1" A / 22mm, 2 priključka	37,00	
004B2901	Set varilnih priključkov G 1" A / DN15, 2 priključka	28,00	
003H6909	Set varilnih priključkov G 1" A / DN20, 2 priključka	37,50	
004B2913	Set navojnih priključkov G 1" A / G 3/4 A, 2 priključka	47,00	

Montažna konzola

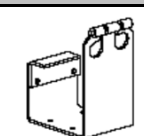
004B1728	Montažna konzola za XB 37	57,00	
----------	---------------------------	-------	---

Izolacije

T_{maks}=130°C, kratkotrajno do 150°C

004B1721	Izol. XB 37L-1: 10 -> 20	101,00	
004B1722	Izol. XB 37L-1: 26 -> 36	104,00	
004B1723	Izol. XB 37L-1: 40 -> 50	107,00	
004B1725	Izol. XB 37L-1: 60 -> 80	110,00	
004B1726	⊙ Izol. XB 37L-1: 90 -> 100	113,20	
004B1727	⊙ Izol. XB 37L-1: 110 -> 120	116,00	

Prenosniki toplote

Koda	Tip	Masa [kg]	Dolž. (F+E) [mm]	Priključek		Cena EUR
				vrsta	dimenzija	

Lotani prenosnik toplote z enim prehodom XB, tip 37M

XB 37M-1

material plošč nerjaveče jeklo 1.4404, lotani z bakrom, PN25, primeren za obtočno in sanitarno vodo ter mešanice glikol/voda do 50% glikola, maks. temperatura medija 180°C, min. temperatura medija -10°C, pri temperaturah pod 2°C mora biti uporabljena mešanica glikola in vode.

Dimenzije: horizontalna/vertikalna razdalja med priključki D/C=72/479mm, širina/višina B/A=119/525mm.

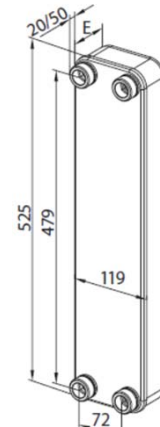

004H7285	XB 37M-1 10	4	46,8	zunanj cilindrični navoj ISO 228/1	G 1" A	227,00	
004H7286	XB 37M-1 16	5	56,9			262,00	
004H7287	XB 37M-1 20	6	63,6			284,00	
004H7288	XB 37M-1 26	7	73,7			317,00	
004H7289	XB 37M-1 30	8	80,4			340,00	
004H7290	XB 37M-1 36	9	90,5			371,00	
004H7291	XB 37M-1 40	9	97,2			395,00	
004H7292	XB 37M-1 50	11	114,0			451,00	
004H7293	XB 37M-1 60	12	130,8			506,00	
004H7294	XB 37M-1 70	14	147,6			561,00	
004H7295	XB 37M-1 80	16	164,4			616,00	
004H7296	XB 37M-1 90	17	181,2			672,00	
004H7297	XB 37M-1 100	19	198,0			727,00	
004H7298	XB 37M-1 110	20	214,8			783,00	
004H7299	XB 37M-1 120	22	231,6	838,00			

DN 25

Dodatki

Koda	Tip, opis	Cena EUR
------	-----------	----------

Priključki

004B2904	© Set priključkov za lotanje G 1" A / 15mm, 2 priključka	37,00	
004B2905	© Set priključkov za lotanje G 1" A / 18mm, 2 priključka	35,00	
004B2906	Set priključkov za lotanje G 1" A / 22mm, 2 priključka	37,00	
004B2901	Set varilnih priključkov G 1" A / DN15, 2 priključka	28,00	
003H6909	Set varilnih priključkov G 1" A / DN20, 2 priključka	37,50	
004B2913	Set navojnih priključkov G 1" A / G 3/4 A, 2 priključka	47,00	

Montažna konzola

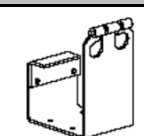
004B1728	Montažna konzola za XB 37	57,00	
----------	---------------------------	-------	---

Izolacije

T_{maks}=130°C, kratkotrajno do 150°C

004B1721	Izol. XB 37M-1: 10 -> 26	101,00	
004B1722	Izol. XB 37M-1: 30 -> 40	104,00	
004B1723	Izol. XB 37M-1: 50 -> 70	107,00	
004B1725	Izol. XB 37M-1: 80 -> 100	110,00	
004B1726	© Izol. XB 37M-1: 110 -> 120	113,20	

Prenosniki toplote

Koda	Tip	Masa [kg]	Dolž. (F+E) [mm]	Priključek		Cena EUR
				vrsta	dimenzija	

Lotani prenosnik toplote z enim prehodom XB, tip 37H

XB 37H-1

material plošč nerjaveče jeklo 1.4404, lotani z bakrom, PN25, primeren za obtočno in sanitarno vodo ter mešanice glikol/voda do 50% glikola, maks. temperatura medija 180°C, min. temperatura medija -10°C, pri temperaturah pod 2°C mora biti uporabljena mešanica glikola in vode.

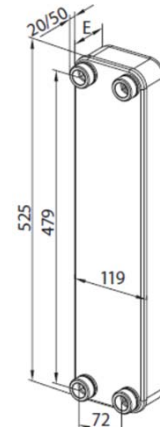

Dimenzije: horizontalna/vertikalna razdalja med priključki D/C=72/479mm, širina/višina B/A=119/525mm.

004H7300	XB 37H-1 10	4	44,6	zunanj cilindrični navoj ISO 228/1	G 1" A	228,00	
004H7301	XB 37H-1 16	5	53,4			262,00	
004H7302	XB 37H-1 20	6	59,2			284,00	
004H7303	XB 37H-1 26	7	68,0			317,00	
004H7304	XB 37H-1 30	8	73,8			340,00	
004H7305	XB 37H-1 36	9	82,6			371,00	
004H7306	XB 37H-1 40	9	88,4			395,00	
004H7307	XB 37H-1 50	11	103,0			451,00	
004H7308	XB 37H-1 60	12	117,6			506,00	
004H7309	© XB 37H-1 70	14	132,2			562,00	
004H7310	XB 37H-1 80	16	146,8			616,00	
004H7311	XB 37H-1 90	17	161,4			673,00	
004H7312	XB 37H-1 100	19	176,0			728,00	
004H7313	XB 37H-1 110	20	190,6			783,00	
004H7314	XB 37H-1 120	22	205,2	838,00			

Dodatki

Koda	Tip, opis	Cena EUR
------	-----------	----------

Priključki

004B2904	© Set priključkov za lotanje G 1" A / 15mm, 2 priključka	37,00	
004B2905	© Set priključkov za lotanje G 1" A / 18mm, 2 priključka	35,00	
004B2906	Set priključkov za lotanje G 1" A / 22mm, 2 priključka	37,00	
004B2901	Set varilnih priključkov G 1" A / DN15, 2 priključka	28,00	
003H6909	Set varilnih priključkov G 1" A / DN20, 2 priključka	37,50	
004B2913	Set navojnih priključkov G 1" A / G 3/4 A, 2 priključka	47,00	

Montažna konzola

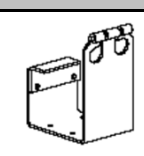
004B1728	Montažna konzola za XB 37	57,00	
----------	---------------------------	-------	---

Izolacije

T_{maks}=130°C, kratkotrajno do 150°C

004B1721	Izol. XB 37H-1: 10 -> 30	101,00	
004B1722	Izol. XB 37H-1: 36 -> 50	104,00	
004B1723	Izol. XB 37H-1: 60 -> 90	107,00	
004B1725	Izol. XB 37H-1: 100 -> 120	110,00	

Prenosniki toplote

Koda	Tip	Masa [kg]	Dolž. (F+E) [mm]	Priključek		Cena EUR
				vrsta	dimenzija	

Lotani prenosnik toplote z enim prehodom XB, tip 12L

XB 12L-1

material plošč nerjaveče jeklo 1.4404, lotani z bakrom, PN25, primeren za obtočno in sanitarno vodo ter mešanice glikol/voda do 50% glikola, maks. temperatura medija 180°C, min. temperatura medija -10°C, pri temperaturah pod 2°C mora biti uporabljena mešanica glikola in vode.

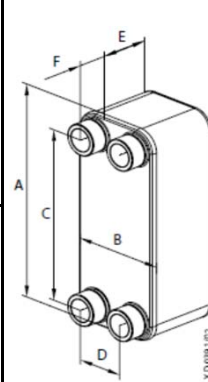

Dimenzije: horizontalna/vertikalna razdalja med priključki D/C=63/234mm, širina/višina B/A=118/289mm.

004H7525	© XB 12L-1 10	3	47,5	zunanji cilindrični navoj ISO 228/1	G 1¼" A	156,00	
004H7526	© XB 12L-1 16	3	58,0			174,00	
004H7527	XB 12L-1 20	4	65,0			192,00	
004H7528	XB 12L-1 26	4	75,5			224,00	
004H7529	XB 12L-1 30	4	82,5			261,00	
004H7530	XB 12L-1 36	5	93,0			278,00	
004H7531	XB 12L-1 40	5	100,0			319,00	
004H7532	XB 12L-1 50	6	117,5			353,00	
004H7533	XB 12L-1 60	7	135,0			412,00	
004H7534	XB 12L-1 70	7	152,5			470,00	
004H7535	XB 12L-1 80	8	170,0			548,00	
004H7536	XB 12L-1 90	9	187,5			605,00	
004H7537	XB 12L-1 100	10	205,0			646,00	
004H7538	XB 12L-1 110	10	222,5			687,00	

Dodatki

Koda	Tip, opis	Cena EUR
------	-----------	----------

Priključki

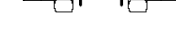
004B1358	© Set priključkov za lotanje G 1¼" A / 28mm, 2 priključka	42,00	
003H6910	Set varilnih priključkov G 1¼" A / DN25, 2 priključka	49,60	
004H4205	© Set navojnih priključkov G 1¼" A / G 1" A, 2 priključka	63,00	
004H4206	© Set navojnih priključkov G 1¼" A / G 1½" A, 2 priključka	74,00	

Montažna konzola

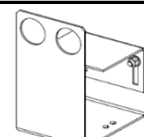
004H4200	© Montažna konzola za XB 12	40,00	
----------	-----------------------------	-------	---

Izolacije

T_{maks}=130°C, kratkotrajno do 160°C

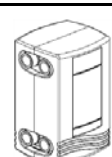
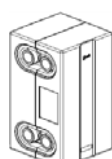
004H4210	PU izolacija za XB12L-1 : 10 -> 36	90,00	
004H4211	PU izolacija za XB12L-1 : 40 -> 70	94,00	
004H4212	PU izolacija za XB12L-1 : 80 -> 100	97,00	
004H4213	PU izolacija za XB12L-1 : 110	100,00	
T _{maks} =110°C			
004H4201	EPP izolacija za XB12L-1 : 10 -> 30	44,00	
004H4202	EPP izolacija za XB12L-1 : 36 -> 60	47,00	
004H4203	EPP izolacija za XB12L-1 : 70 -> 90	50,00	

Prenosniki toplote

Koda	Tip	Masa [kg]	Dolž. (F+E) [mm]	Priključek		Cena EUR
				vrsta	dimenzija	

Lotani prenosnik toplote z enim prehodom XB, tip 12M

XB 12M-1

material plošč nerjaveče jeklo 1.4404, lotani z bakrom, PN25, primeren za obtočno in sanitarno vodo ter mešanice glikol/voda do 50% glikola, maks. temperatura medija 180°C, min. temperatura medija -10°C, pri temperaturah pod 2°C mora biti uporabljena mešanica glikola in vode.



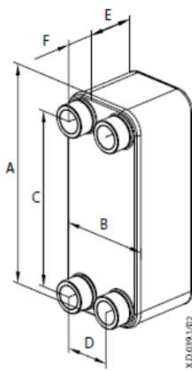

Dimenzije: horizontalna/vertikalna razdalja med priključki D/C=63/234mm, širina/višina B/A=118/289mm.

004H7540	XB 12M-1 10	3	44,0	zunanj cilindrični navoj ISO 228/1	G 1¼" A		156,00
004H7541	© XB 12M-1 16	3	52,4				174,00
004H7542	XB 12M-1 20	4	58,0				192,00
004H7543	XB 12M-1 26	4	66,4				224,00
004H7544	XB 12M-1 30	4	72,0				261,00
004H7545	XB 12M-1 36	5	80,4				278,00
004H7546	XB 12M-1 40	5	86,0				319,00
004H7547	XB 12M-1 50	6	100,0				353,00
004H7548	XB 12M-1 60	7	114,0				412,00
004H7549	XB 12M-1 70	7	128,0				470,00
004H7550	XB 12M-1 80	8	142,0				548,00
004H7551	XB 12M-1 90	9	156,0				605,00
004H7552	XB 12M-1 100	10	170,0				647,00
004H7553	XB 12M-1 110	10	184,0				687,00

Dodatki

Koda	Tip, opis	Cena EUR
------	-----------	----------

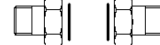
Priključki

004B1358	© Set priključkov za lotanje G 1¼" A / 28mm, 2 priključka	42,00	
003H6910	Set varilnih priključkov G 1¼" A / DN25, 2 priključka	49,60	
004H4205	© Set navojnih priključkov G 1¼" A / G 1" A, 2 priključka	63,00	
004H4206	© Set navojnih priključkov G 1¼" A / G 1½" A, 2 priključka	74,00	

Montažna konzola

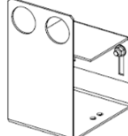
004H4200	© Montažna konzola za XB 12	40,00	
----------	------------------------------------	--------------	---

Izolacije

T_{maks}=130°C, kratkotrajno do 160°C

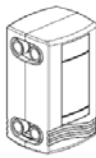
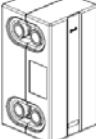
004H4210	PU izolacija za XB12M-1 : 10 -> 40	90,00	
004H4211	PU izolacija za XB12M-1 : 50 -> 90	94,00	
004H4212	PU izolacija za XB12M-1 : 100 -> 110	97,00	
T _{maks} =110°C			
004H4201	EPP izolacija za XB12M-1 : 10 -> 40	44,00	
004H4202	EPP izolacija za XB12M-1 : 50 -> 70	47,00	
004H4203	EPP izolacija za XB12M-1 : 80 -> 110	50,00	

Prenosniki toplote

Koda	Tip	Masa [kg]	Dolž. (F+E) [mm]	Priključek		Cena EUR
				vrsta	dimenzija	

Lotani prenosnik toplote z enim prehodom XB, tip 12H

XB 12H-1

material plošč nerjaveče jeklo 1.4404, lotani z bakrom, PN25, primeren za obtočno in sanitarno vodo ter mešanice glikol/voda do 50% glikola, maks. temperatura medija 180°C, min. temperatura medija -10°C, pri temperaturah pod 2°C mora biti uporabljena mešanica glikola in vode.

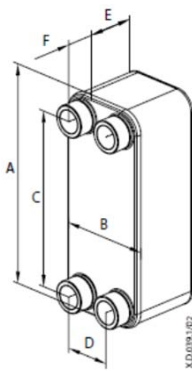

Dimenzije: horizontalna/vertikalna razdalja med priključki D/C=63/234mm, širina/višina B/A=118/289mm.

004H7555	© XB 12H-1 10	3	42,0	zunajni cilindrični navoj ISO 228/1	G 1¼" A	156,00		DN 32
004H7556	© XB 12H-1 16	3	49,2			173,00		
004H7557	© XB 12H-1 20	4	54,0			192,00		
004H7558	© XB 12H-1 26	4	61,2			224,00		
004H7559	XB 12H-1 30	4	66,0			261,00		
004H7560	© XB 12H-1 36	5	73,2			278,00		
004H7561	XB 12H-1 40	5	78,0			319,00		
004H7562	XB 12H-1 50	6	90,0			352,00		
004H7563	XB 12H-1 60	7	102,0			412,00		
004H7564	XB 12H-1 70	7	114,0			470,00		
004H7565	XB 12H-1 80	8	126,0			548,00		
004H7566	XB 12H-1 90	9	138,0			605,00		
004H7567	XB 12H-1 100	10	150,0			647,00		
004H7568	XB 12H-1 110	10	162,0	687,00				
004H7569	XB 12H-1 120	11	174,0	728,00				
004H7570	XB 12H-1 140	13	198,0	807,00				

Dodatki

Koda	Tip, opis	Cena EUR
------	-----------	----------

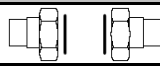
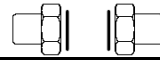
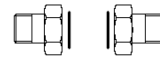
Priključki

004B1358	© Set priključkov za lotanje G 1¼" A / 28mm, 2 priključka	42,00	
003H6910	Set varilnih priključkov G 1¼" A / DN25, 2 priključka	49,60	
004H4205	© Set navojnih priključkov G 1¼" A / G 1" A, 2 priključka	63,00	
004H4206	© Set navojnih priključkov G 1¼" A / G 1½" A, 2 priključka	74,00	

Montažna konzola

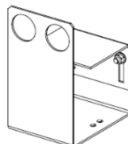
004H4200	© Montažna konzola za XB 12	40,00	
----------	-----------------------------	-------	---

Izolacije

T_{maks}=130°C, kratkotrajno do 160°C

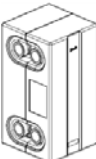
004H4210	PU izolacija za XB12H-1 : 10 -> 50	90,00	
004H4211	PU izolacija za XB12H-1 : 60 -> 100	94,00	
004H4212	PU izolacija za XB12H-1 : 110 -> 140	97,00	
T _{maks} =110°C			
004H4201	EPP izolacija za XB12H-1 : 10 -> 40	44,00	
004H4202	EPP izolacija za XB12H-1 : 50 -> 80	47,00	
004H4203	EPP izolacija za XB12H-1 : 90 -> 120	50,00	

Prenosniki toplote

Koda	Tip	Masa [kg]	Dolž. (F+E) [mm]	Priključek		Cena EUR	
				vrsta	dimenzija		

Lotani prenosnik toplote z enim prehodom XB, tip 51L

XB 51L-1

material plošč nerjaveče jeklo 1.4404, lotani z bakrom, PN25, primeren za obtočno in sanitarno vodo ter mešanice glikol/voda do 50% glikola, maks. temperatura medija 180°C, min. temperatura medija -10°C, pri temperaturah pod 0°C mora biti uporabljena mešanica glikola in vode.

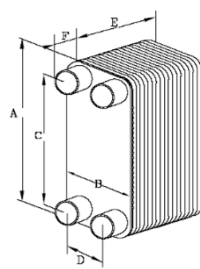

Dimenzije: horizontalna/vertikalna razdalja med priključki D/C=170/380mm, širina/višina B/A=253/462mm.

004B1141	© XB 51L-1 10	12	88,0	zunanj cilindrični navoj ISO 228/1	G 2" A	512,00	
004B1142	© XB 51L-1 16	15	103,6			600,00	
004B1532	© XB 51L-1 20	16	114,0			724,00	
004B1533	© XB 51L-1 26	18	129,6			830,00	
004B1194	XB 51L-1 30	20	140,0			893,00	
004B1195	XB 51L-1 36	22	155,6			996,00	
004B1196	XB 51L-1 40	24	166,0			1.090,00	
004B1197	XB 51L-1 50	27	192,0			1.200,00	
004B1198	XB 51L-1 60	31	218,0			1.310,00	
004B1199	© XB 51L-1 70	35	244,0			1.420,00	
004B1200	© XB 51L-1 80	39	270,0			1.570,00	
004B1201	© XB 51L-1 90	43	296,0			1.700,00	
004B1202	© XB 51L-1 100	46	322,0			1.850,00	
004B1203	© XB 51L-1 110	50	348,0			1.960,00	
004B1204	© XB 51L-1 120	54	374,0	2.080,00			
004B1534	© XB 51L-1 130	58	400,0	2.060,00			
004B1536	© XB 51L-1 140	62	426,0	2.183,00			

Dodatki

Koda	Tip, opis	Cena EUR	
------	-----------	----------	--

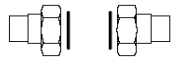
Priključki

004B2910	© Set priključkov za lotanje G 2" A / 28mm, 2 priključka	72,00	
004B2911	© Set priključkov za lotanje G 2" A / 35mm, 2 priključka	77,00	
004B2912	Set priključkov za lotanje G 2" A / 42mm, 2 priključka	74,00	
065B2006	Set varilnih priključkov G 2" A / DN 40, 2 priključka	88,60	

Montažna konzola

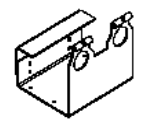
004H4518	© Montažna konzola za XB 51	72,00	
----------	-----------------------------	-------	---

Izolacije

T_{maks} = 130°C, kratkotrajno do 150°C

004B1924	Izolacija za XB51-1 : 10 -> 48	118,00	
004B1935	Izolacija za XB51-1 : 50 -> 70	131,00	
004B1950	Izolacija za XB51-1 : 80 -> 100	141,00	
004B1960	Izolacija za XB51-1 : 110 -> 120	151,00	
004B3735	Izolacija za XB51-1 : 140	162,00	

Prenosniki toplote

Koda	Tip	Masa [kg]	Dolž. (F+E) [mm]	Prikluček		Cena EUR
				vrsta	dimenzija	

Lotani prenosnik toplote z enim preходом XB, tip 52M

XB 52M-1

material plošč nerjaveče jeklo 1.4404, lotani z bakrom, PN25, primeren za obtočno in sanitarno vodo ter mešanice glikol/voda do 50% glikola, maks. temperatura medija 180°C, min. temperatura medija -10°C, pri temperaturah pod 0°C mora biti uporabljena mešanica glikola in vode.

Dimenzije: horizontalna/vertikalna razdalja med priključki D/C=170/379mm, širina/višina B/A=256/466mm.

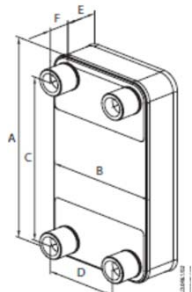
004H4520	XB 52M-1 20	13	102,6	zunanj cilindrični navoj ISO 228/1	G 2" A	661,00	
004H4521	XB 52M-1 26	15	113,1			759,00	
004H4522	XB 52M-1 30	16	120,1			831,00	
004H4523	XB 52M-1 36	18	130,6			914,00	
004H4524	XB 52M-1 40	19	137,6			960,00	
004H4525	XB 52M-1 50	21	155,1			1.070,00	
004H4526	XB 52M-1 60	24	172,6			1.180,00	
004H4527	XB 52M-1 70	27	190,1			1.280,00	
004H4528	XB 52M-1 80	29	207,6			1.410,00	
004H4529	XB 52M-1 90	32	225,1			1.580,00	
004H4530	XB 52M-1 100	35	242,6			1.710,00	
004H4531	XB 52M-1 110	38	260,1			1.830,00	
004H4532	XB 52M-1 120	40	277,6			1.940,00	
004H4533	XB 52M-1 130	43	295,1	2.060,00			
004H4534	XB 52M-1 140	46	312,6	2.180,00			

Dodatki

Koda	Tip, opis	Cena EUR
------	-----------	----------

Priključki

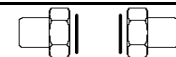
004B2910	© Set priključkov za lotanje G 2" A / 28mm, 2 priključka	72,00	
004B2911	© Set priključkov za lotanje G 2" A / 35mm, 2 priključka	77,00	
004B2912	Set priključkov za lotanje G 2" A / 42mm, 2 priključka	74,00	
065B2006	Set varilnih priključkov G 2" A / DN 40, 2 priključka	88,60	

Montažna konzola

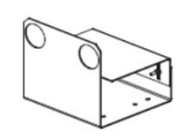
004H4518	© Montažna konzola za XB 52M	72,00	
----------	------------------------------	-------	---

Izolacije

T_{maks}=130°C, kratkotrajno do 150°C

004B1924	Izolacija za XB 52M-1 : 20 -> 70	118,00	
004B1935	Izolacija za XB 52M-1 : 80 -> 100	131,00	
004B1950	Izolacija za XB 52M-1 : 110 -> 140	141,00	

Prenosniki toplote

Koda	Tip	Masa [kg]	Dolž. (A) [mm]	Priključek		Cena EUR	
				vrsta	dimenzija		

Lotani prenosnik toplote z enim prehodom XB, tip 59M

XB 59M-1

material plošč nerjaveče jeklo 1.4404, lotani z bakrom, PN25, primeren za obtočno in sanitarno vodo ter mešanice glikol/voda do 50% glikola, maks. temperatura medija 180°C, min. temperatura medija -10°C, pri temperaturah pod 0°C mora biti uporabljena mešanica glikola in vode.

Dimenzije: horizontalna/vertikalna razdalja med priključki 92/519mm, širina/višina 186/613mm.

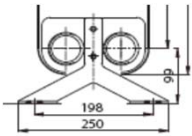
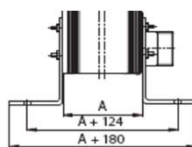
004B1920	XB 59M-1 30	14	63,7	zunani cilindrični navoj ISO 228/1	G 2" A	798,00	
004B1921	XB 59M-1 36	16	74,1			856,00	
004B1922	XB 59M-1 40	17	81,1			913,00	
004B1923	XB 59M-1 50	20	98,5			1.010,00	
004B1932	XB 59M-1 60	23	115,9			1.140,00	
004B1933	XB 59M-1 70	25	133,3			1.200,00	
004B1934	XB 59M-1 80	28	150,7			1.300,00	
004B1936	XB 59M-1 90	31	168,1			1.430,00	
004B1937	XB 59M-1 100	34	185,5			1.520,00	
004B1938	XB 59M-1 110	37	202,9			1.620,00	
004B1939	XB 59M-1 120	40	220,3			1.720,00	
004B1940	XB 59M-1 140	46	255,1			1.900,00	
004B1941	XB 59M-1 160	52	289,9			2.100,00	
004B1942	XB 59M-1 180	57	324,7	2.290,00			
004B1943	XB 59M-1 200	63	359,5	2.480,00			

Dodatki

Koda	Tip, opis	Cena EUR	
------	-----------	----------	--

Priključki

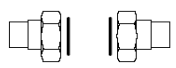
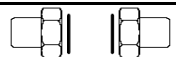
004B2910	⊙ Set priključkov za lotanje G 2" A / 28mm, 2 priključka	72,00	
004B2911	⊙ Set priključkov za lotanje G 2" A / 35mm, 2 priključka	77,00	
004B2912	Set priključkov za lotanje G 2" A / 42mm, 2 priključka	74,00	
065B2006	Set varilnih priključkov G 2" A / DN 40, 2 priključka	88,60	

Montažna konzola

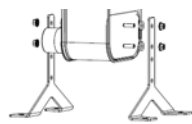
004B1245	⊙ Montažna konzola za XB 59 sestavljena iz dveh stojal, 4 matic in dveh distančnih obročkov	58,00	
----------	---	--------------	---

Izolacije

T_{maks} = 130°C, kratkotrajno do 150°C

004B1651	Izolacija XB 59-1: 30 -> 50	151,00	
004B1652	Izolacija XB 59-1: 51 -> 100	175,00	
004B1653	Izolacija XB 59-1: 101 -> 140	209,00	
004B1654	Izolacija XB 59-1: 141 -> 200	256,00	

Prenosniki toplote

Koda	Tip	Masa [kg]	Dolž. (A) [mm]	Priključek		Cena EUR	
				vrsta	dimenzija		

Lotani prenosnik toplote z enim prehodom XB, tip 61L

XB 61L-1

material plošč nerjaveče jeklo 1.4404, lotani z bakrom, PN25, primeren za obtočno in sanitarno vodo ter mešanice glikol/voda do 50% glikola, maks. temperatura medija 180°C, min. temperatura medija -10°C, pri temperaturah pod 0°C mora biti uporabljena mešanica glikola in vode.

Dimenzije: horizontalna/vertikalna razdalja med priključki 174/456mm, širina/višina 243/525mm.

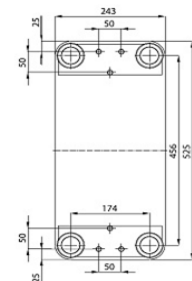

004B1906	XB 61L-1 30 SB	18	79,2	zunanj cilindrični navoj ISO 228/1	G 2" A	855,00	
004B1907	© XB 61L-1 36 SB	20	92,6			917,00	
004B1908	XB 61L-1 40 SB	21	101,6			965,00	
004B1909	XB 61L-1 50 SB	24	124,0			1.070,00	
004B1910	XB 61L-1 60 SB	27	146,4			1.180,00	
004B1911	XB 61L-1 70 SB	30	168,8			1.286,00	
004B1912	XB 61L-1 80 SB	33	191,2			1.409,00	
004B3436	© XB 61L-1 90 SB	36	213,6			1.503,00	
004B3437	© XB 61L-1 100 SB	39	236,0			1.638,00	
004B3438	© XB 61L-1 110 SB	42	258,4			1.722,00	
004B3439	© XB 61L-1 120 SB	45	280,8			1.862,00	
004B3440	© XB 61L-1 140 SB	51	325,6			1.943,00	
004B3441	© XB 61L-1 160 SB	57	370,4	2.124,00			
004B3442	© XB 61L-1 180 SB	63	415,2	2.324,00			
004B3443	© XB 61L-1 200 SB	69	460,0	2.521,00			

DN 50

Dodatki

Koda	Tip, opis	Cena EUR	
------	-----------	----------	--

Priključki

004B2910	© Set priključkov za lotanje G 2" A / 28mm, 2 priključka	72,00	
004B2911	© Set priključkov za lotanje G 2" A / 35mm, 2 priključka	77,00	
004B2912	Set priključkov za lotanje G 2" A / 42mm, 2 priključka	74,00	
065B2006	Set varilnih priključkov G 2" A / DN 40, 2 priključka	88,60	

Montažna konzola

004B1788	Montažna konzola za XB 61: L30-60	74,00	
004B1789	© Montažna konzola za XB 61: L61-120	86,00	
004B1790	Montažna konzola za XB 61: L121-200	98,00	

Izolacije

T_{maks}=130°C, kratkotrajno do 150°C

004B1655	Izol. XB 61L-1: 30 -> 50	151,00	
004B1656	Izol. XB 61L-1: 51 -> 100	175,00	
004B1657	Izol. XB 61L-1: 101 -> 140	209,00	
004B1658	Izol. XB 61L-1: 141 -> 200	255,00	

Prenosniki toplote

Koda	Tip	Masa [kg]	Dolž. (A) [mm]	Priključek		Cena EUR	
				vrsta	dimenzija		

Lotani prenosnik toplote z enim prehodom XB, tip 61M

XB 61M-1

material plošč nerjaveče jeklo 1.4404, lotani z bakrom, PN25, primeren za obtočno in sanitarno vodo ter mešanice glikol/voda do 50% glikola, maks. temperatura medija 180°C, min. temperatura medija -10°C, pri temperaturah pod 0°C mora biti uporabljena mešanica glikola in vode.

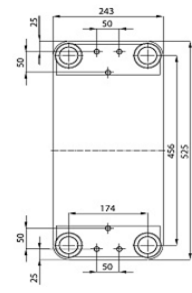

Dimenzije: horizontalna/vertikalna razdalja med priključki 174/456mm, širina/višina 243/525mm.

004B1913	XB 61M-1 30 SB	18	64,2	zunanj cilindrični navoj ISO 228/1	G 2" A	855,00	
004B1914	© XB 61M-1 36 SB	20	74,6			917,00	
004B1915	XB 61M-1 40 SB	21	81,6			964,00	
004B1916	XB 61M-1 50 SB	24	99,0			1.070,00	
004B1917	XB 61M-1 60 SB	27	116,4			1.180,00	
004B1918	XB 61M-1 70 SB	30	133,8			1.290,00	
004B1919	XB 61M-1 80 SB	33	151,2			1.410,00	
004B3444	© XB 61M-1 90 SB	36	168,6			1.503,00	
004B3445	© XB 61M-1 100 SB	39	186,0			1.638,00	
004B3446	© XB 61M-1 110 SB	42	203,4			1.722,00	
004B3447	© XB 61M-1 120 SB	45	220,8			1.862,00	
004B3448	© XB 61M-1 140 SB	51	255,6			1.943,00	
004B3449	© XB 61M-1 160 SB	57	290,4			2.124,00	
004B3450	© XB 61M-1 180 SB	63	325,2	2.324,00			
004B3451	© XB 61M-1 200 SB	69	360,0	2.521,00			

Dodatki

Koda	Tip, opis	Cena EUR	
------	-----------	----------	--

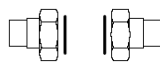
Priključki

004B2910	© Set priključkov za lotanje G 2" A / 28mm, 2 priključka	72,00	
004B2911	© Set priključkov za lotanje G 2" A / 35mm, 2 priključka	77,00	
004B2912	Set priključkov za lotanje G 2" A / 42mm, 2 priključka	74,00	
065B2006	Set varilnih priključkov G 2" A / DN 40, 2 priključka	88,60	

Montažna konzola

004B1788	Montažna konzola za XB 61: M30-70	74,00	
004B1789	© Montažna konzola za XB 61: M71-160	86,00	
004B1790	Montažna konzola za XB 61: M161-200	98,00	

Izolacije

T_{maks}=130°C, kratkotrajno do 150°C

004B1655	Izol. XB 61M-1: 30 -> 70	151,00	
004B1656	Izol. XB 61M-1: 71 -> 120	175,00	
004B1657	Izol. XB 61M-1: 121 -> 180	209,00	
004B1658	Izol. XB 61M-1: 181 -> 200	255,00	

Prenosniki toplote

Koda	Tip	Masa [kg]	Dolž. (A) [mm]	Priključek		Cena EUR	
				vrsta	dimenzija		

Lotani prenosnik toplote z enim preходом XB, tip 61H

XB 61H-1

material plošč nerjaveče jeklo 1.4404, lotani z bakrom, PN25, primeren za obtočno in sanitarno vodo ter mešanice glikol/voda do 50% glikola, maks. temperatura medija 180°C, min. temperatura medija -10°C, pri temperaturah pod 0°C mora biti uporabljena mešanica glikola in vode.

Dimenzije: horizontalna/vertikalna razdalja med priključki 174/456mm, širina/višina 243/525mm.

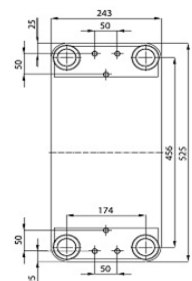

004B1925	© XB 61H-1 30 SB	18	55,2	zunani cilindrični navoj ISO 228/1	G 2" A	855,00	
004B1926	© XB 61H-1 36 SB	20	63,8			917,00	
004B1927	© XB 61H-1 40 SB	21	69,6			964,00	
004B1928	XB 61H-1 50 SB	24	84,0			1.069,00	
004B1929	XB 61H-1 60 SB	27	98,4			1.180,00	
004B1930	XB 61H-1 70 SB	30	112,8			1.290,00	
004B1931	XB 61H-1 80 SB	33	127,2			1.410,00	
004B3452	© XB 61H-1 90 SB	36	141,6			1.500,00	
004B3453	© XB 61H-1 100 SB	39	156,0			1.638,00	
004B3454	© XB 61H-1 110 SB	42	170,4			1.722,00	
004B3455	© XB 61H-1 120 SB	45	184,8			1.860,00	
004B3456	© XB 61H-1 140 SB	51	213,6			1.943,00	
004B3457	© XB 61H-1 160 SB	57	242,4			2.124,00	
004B3458	© XB 61H-1 180 SB	63	271,2	2.324,00			
004B3459	© XB 61H-1 200 SB	69	300,0	2.521,00			

DN 50

Dodatki

Koda	Tip, opis	Cena EUR	
------	-----------	----------	--

Priključki

004B2910	© Set priključkov za lotanje G 2" A / 28mm, 2 priključka	72,00	
004B2911	© Set priključkov za lotanje G 2" A / 35mm, 2 priključka	77,00	
004B2912	Set priključkov za lotanje G 2" A / 42mm, 2 priključka	74,00	
065B2006	Set varilnih priključkov G 2" A / DN 40, 2 priključka	88,60	

Montažna konzola

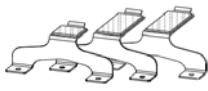
004B1788	Montažna konzola za XB 61: H30-90	74,00	
004B1789	© Montažna konzola za XB 61: H91-180	86,00	
004B1790	Montažna konzola za XB 61: H181-200	98,00	

Izolacije

T_{max} = 130°C, kratkotrajno do 150°C

004B1655	Izol. XB 61H-1: 30 -> 90	151,00	
004B1656	Izol. XB 61H-1: 31 -> 160	175,00	
004B1657	Izol. XB 61H-1: 161 -> 200	209,00	

Prenosniki toplote

Koda	Tip	Masa [kg]	Dolž. (A) [mm]	Priključek		Cena EUR
				vrsta	dimenzija	

Lotani prenosnik toplote z enim preходом XB, tip 66L

XB 66L-1

material plošč nerjaveče jeklo 1.4404, lotani z bakrom, PN25, primeren za obtočno in sanitarno vodo ter mešanice glikol/voda do 50% glikola, maks. temperatura medija 180°C, min. temperatura medija -10°C, pri temperaturah pod 0°C mora biti uporabljena mešanica glikola in vode.

Dimenzije: horizontalna/vertikalna razdalja med priključki 180/583,2mm, širina/višina 296/706mm.

004B1961	© XB 66L-1 40 SB	36	124	kompaktni prirobnici ¹⁾ dolžina 80mm	DN65	2.748,00	
004B1962	© XB 66L-1 50 SB	42	152			2.909,00	
004B1963	© XB 66L-1 60 SB	47	180			3.110,00	
004B1964	© XB 66L-1 70 SB	52	208			3.410,00	
004B1965	© XB 66L-1 80 SB	57	236			3.580,00	
004B1966	© XB 66L-1 90 SB	62	264			3.750,00	
004B1967	© XB 66L-1 100 SB	68	292			3.990,00	
004B1968	© XB 66L-1 110 SB	73	320			4.350,00	
004B1969	© XB 66L-1 120 SB	78	348	4.620,00			
004B1970	© XB 66L-1 140 SB	89	404	5.029,00			
004B1971	© XB 66L-1 160 SB	99	460	5.596,00			

¹⁾ Prenosniki tipa XB 66L so opremljeni s kompaktnimi prirobnici. Uporaba standardnih prirobnic ni možna, priporočamo uporabo Danfossovih protiprirobnic, glejte dodatke.

Dodatki

Koda	Tip, opis	Cena EUR
------	-----------	----------

Priključki

004B3545	© Komplet 4 prirobnic: XB66 DN65cf ogrevanje/STV	448,00
004B3546	© Komplet 4 prirobnic: XB66 DN65cf ogrevanje/ogrevanje	281,00

Montažna konzola

004B1788	Montažna konzola za XB 66: L40-60	74,00	
004B1789	Montažna konzola za XB 66: L61-110	86,00	
004B1790	Montažna konzola za XB 66: L111-160	98,00	

Izolacije

T_{maks}=130°C, kratkotrajno do 150°C

004B3542	© Izol. XB 66L-1: 40 -> 60	215,00	
004B3543	Izol. XB 66L-1: 61 -> 110	290,00	
004B3544	© Izol. XB 66H-1: 111 -> 160	368,00	

Prenosniki toplote

Koda	Tip	Masa [kg]	Dolž. (A) [mm]	Priključek		Cena EUR	
				vrsta	dimenzija		

Lotani prenosnik toplote z enim prehodom XB, tip 66H

XB 66H-1

material plošč nerjaveče jeklo 1.4404, lotani z bakrom, PN25, primeren za obtočno in sanitarno vodo ter mešanice glikol/voda do 50% glikola, maks. temperatura medija 180°C, min. temperatura medija -10°C, pri temperaturah pod 0°C mora biti uporabljena mešanica glikola in vode.

Dimenzije: horizontalna/vertikalna razdalja med priključki 180/583,2mm, širina/višina 296/706mm.

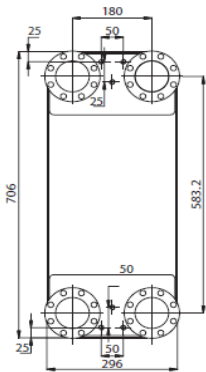
004B1987	© XB 66H-1 40 SB	33	70	kompaktni prirobnični ¹⁾ dolžina 80mm	DN65	2.748,00	
004B1988	© XB 66H-1 50 SB	38	84,5			2.909,00	
004B1989	© XB 66H-1 60 SB	42	99			3.110,00	
004B1990	© XB 66H-1 70 SB	46	113,5			3.412,00	
004B1991	© XB 66H-1 80 SB	51	128			3.581,00	
004B1992	© XB 66H-1 90 SB	55	142,5			3.750,00	
004B1993	© XB 66H-1 100 SB	60	157			3.984,00	
004B1994	© XB 66H-1 110 SB	64	171,5			4.350,00	
004B1995	© XB 66H-1 120 SB	69	186			4.616,00	
004B1996	© XB 66H-1 140 SB	77	215			5.030,00	
004B1997	© XB 66H-1 160 SB	86	244	5.596,00			
004B1998	© XB 66H-1 180 SB	95	273	6.162,00			
004B1999	© XB 66H-1 200 SB	104	302	6.730,00			

¹⁾ Prenosniki tipa XB 66H so opremljeni s kompaktnimi prirobnicami. Uporaba standardnih prirobnic ni možna, priporočamo uporabo Danfossovih protiprirobnic, glejte dodatke.

DN 65

Dodatki

Koda	Tip, opis	Cena EUR	
------	-----------	----------	--

Priključki

004B3545	© Komplet 4 prirobnic: XB66 DN65cf ogrevanje/STV	448,00	
004B3546	© Komplet 4 prirobnic: XB66 DN65cf ogrevanje/ogrevanje	281,00	

Montažna konzola

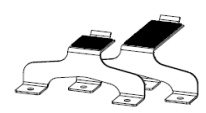
004B1788	Montažna konzola za XB 66: H40-90	74,00	
004B1789	Montažna konzola za XB 66: H91-200	86,00	

Izolacije

T_{maks}=130°C, kratkotrajno do 150°C

004B3542	© Izol. XB 66H-1: 40 -> 90	215,00	
004B3543	© Izol. XB 66H-1: 91 -> 200	290,00	

Prenosniki toplote

Koda	Tip	Masa [kg]	Dolž. (E+F) [mm]	Priključek		Cena EUR
				vrsta	dimenzija	

Lotani prenosnik toplote z enim prehodom XB, tip 70L

XB 70L-1

material plošč nerjaveče jeklo 1.4404, lotani z bakrom, PN25, maks. delovni tlak na sekundarju 16 bar, primeren za obtočno in sanitarno vodo ter mešanice glikol/voda do 50% glikola, maks. temperatura medija 180°C, min. temperatura medija -10°C, pri temperaturah pod 0°C mora biti uporabljena mešanica glikola in vode.

Dimenzije: horizontalna razdalja med priključki D=214mm,

vertikalna razdalja med priključki C=861mm, C1=816mm,

širina/višina plošč B/A=365/990mm, višina vrhnjega roba plošč 1102mm,

širina podnožja 460mm, dolžina podnožja zadaj 75mm, višina nosilcev za transport 1192mm,

širina izolacije 425mm.

Prenosniki toplote serije XB 70 so dobavljeni z podnožjem.

004B2425	XB 70L-1 50	115	235	Prirobnice primar PN25 EN 1092, oblika B(B1)	primar DN65	4.090,00
004B2430	XB 70L-1 60	130	262			4.460,00
004B2435	XB 70L-1 70	145	289			4.830,00
004B2440	XB 70L-1 80	160	316			5.240,00
004B2445	XB 70L-1 90	175	343			5.770,00
004B2450	XB 70L-1 100	190	370	sekundar PN16 EN 1092, oblika B(B1)	sekundar DN100	6.300,00
004B2455	XB 70L-1 110	205	397			6.830,00
004B2460	© XB 70L-1 120	220	424			7.350,00
004B2470	XB 70L-1 140	250	478			8.410,00
004B2480	XB 70L-1 160	280	532			9.470,00
004B2490	© XB 70L-1 180	310	586	10.520,00		
004B2499	XB 70L-1 200	340	640	11.580,00		

Dodatki

Koda	Tip, opis	Cena EUR
------	-----------	----------

Izolacije

T_{maks}=150°C, kratkotrajno do 180°C

004B2535	Izolacija za XB70-1 : 50 -> 70	253,00	
004B2550	Izolacija za XB70-1 : 80 -> 100	260,00	
004B2570	Izolacija za XB70-1 : 110 -> 140	270,00	
004B2599	Izolacija za XB70-1 : 160 -> 200	284,00	

Dimenzijska skica prenosnika toplote serije XB 70

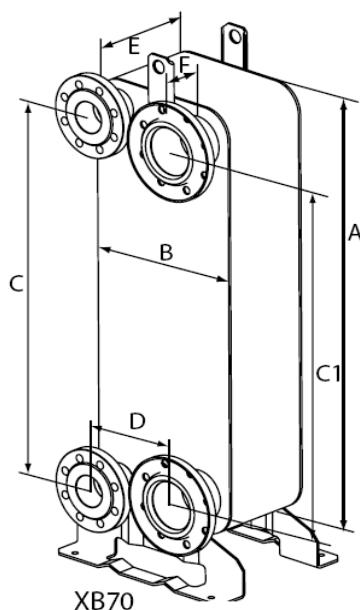

Prenosniki toplote

Koda	Tip	Masa [kg]	Dolž. (E+F) [mm]	Prikluček		Cena EUR
				vrsta	dimenzija	

Lotani prenosnik toplote z enim preходом XB, tip 70M

XB 70M-1

material plošč nerjaveče jeklo 1.4404, lotani z bakrom, PN25, maks. delovni tlak na sekundarju 16 bar, primeren za obtočno in sanitarno vodo ter mešanice glikol/voda do 50% glikola, maks. temperatura medija 180°C, min. temperatura medija -10°C, pri temperaturah pod 0°C mora biti uporabljena mešanica glikola in vode.

Dimenzije: horizontalna razdalja med priključki D=214mm,

vertikalna razdalja med priključki C=861mm, C1=816mm,

širina/višina plošč B/A=365/990mm, višina vrhnjega roba plošč 1102mm,

širina podnožja 460mm, dolžina podnožja zadaj 75mm, višina nosilcev za transport 1192mm,

širina izolacije 425mm.

Prenosniki toplote serije XB 70 so dobavljeni z podnožjem.

004B2000	© XB 70M-1 50	115	235	Prirobnice primar PN25 EN 1092, oblika B(B1)	primar DN65	4.090,00
004B2001	© XB 70M-1 60	130	262			4.460,00
004B2002	© XB 70M-1 70	145	289			4.830,00
004B2003	© XB 70M-1 80	160	316			5.240,00
004B2004	© XB 70M-1 90	175	343			5.770,00
004B2005	© XB 70M-1 100	190	370			6.300,00
004B2006	© XB 70M-1 110	205	397	sekundar PN16 EN 1092, oblika B(B1)	sekundar DN100	6.830,00
004B2007	© XB 70M-1 120	220	424			7.350,00
004B2008	© XB 70M-1 140	250	478			8.410,00
004B2009	© XB 70M-1 160	280	532			9.470,00
004B2010	© XB 70M-1 180	310	586			10.520,00
004B2011	© XB 70M-1 200	340	640			11.580,00

DN 65/100

Dodatki

Koda	Tip, opis	Cena EUR
------	-----------	----------

Izolacije

T_{maks}=150°C, kratkotrajno do 180°C

004B2535	Izolacija za XB70-1 : 50 -> 70	253,00	
004B2550	Izolacija za XB70-1 : 80 -> 100	260,00	
004B2570	Izolacija za XB70-1 : 110 -> 140	270,00	
004B2599	Izolacija za XB70-1 : 160 -> 200	284,00	

Dimenzijska skica prenosnika toplote serije XB 70

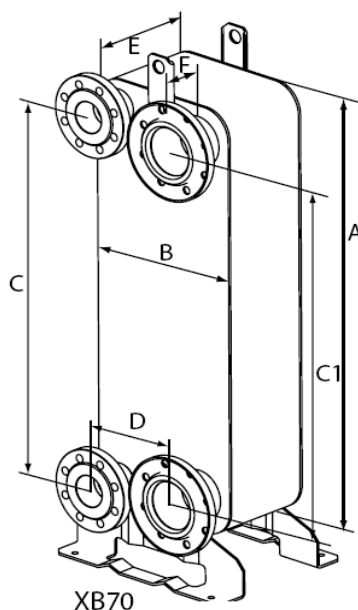

Prenosniki toplote

Koda	Tip	Masa [kg]	Dolž. (E+F) [mm]	Priključek		Cena EUR
				vrsta	dimenzija	

Lotani prenosnik toplote z enim preходом XB, tip 70H

XB 70H-1

material plošč nerjaveče jeklo 1.4404, lotani z bakrom, PN25, maks. delovni tlak na sekundarju 16 bar, primeren za obtočno in sanitarno vodo ter mešanice glikol/voda do 50% glikola, maks. temperatura medija 180°C, min. temperatura medija -10°C, pri temperaturah pod 0°C mora biti uporabljena mešanica glikola in vode.

Dimenzije: horizontalna razdalja med priključki D=214mm,

vertikalna razdalja med priključki C=861mm, C1=816mm,

širina/višina plošč B/A=365/990mm, višina vrhnjega roba plošč 1102mm,

širina podnožja 460mm, dolžina podnožja zadaj 75mm, višina nosilcev za transport 1192mm,

širina izolacije 425mm.

Prenosniki toplote serije XB 70 so dobavljeni z podnožjem.

004B2012	© XB 70H-1 50	115	235	Prirobnice primar PN25 EN 1092, oblika B(B1)	primar DN65	4.090,00
004B2013	XB 70H-1 60	130	262			4.460,00
004B2014	XB 70H-1 70	145	289			4.830,00
004B2015	XB 70H-1 80	160	316			5.240,00
004B2016	XB 70H-1 90	175	343			5.770,00
004B2017	XB 70H-1 100	190	370	sekundar PN16 EN 1092, oblika B(B1)	sekundar DN100	6.300,00
004B2018	© XB 70H-1 110	205	397			6.830,00
004B2019	XB 70H-1 120	220	424			7.354,00
004B2020	© XB 70H-1 140	250	478			8.410,00

Dodatki

Koda	Tip, opis	Cena EUR
------	-----------	----------

Izolacije

T_{maks}=150°C, kratkotrajno do 180°C

004B2535	Izolacija za XB70-1 : 50 -> 70	253,00	
004B2550	Izolacija za XB70-1 : 80 -> 100	260,00	
004B2570	Izolacija za XB70-1 : 110 -> 140	270,00	

Dimenzijska skica prenosnika toplote serije XB 70

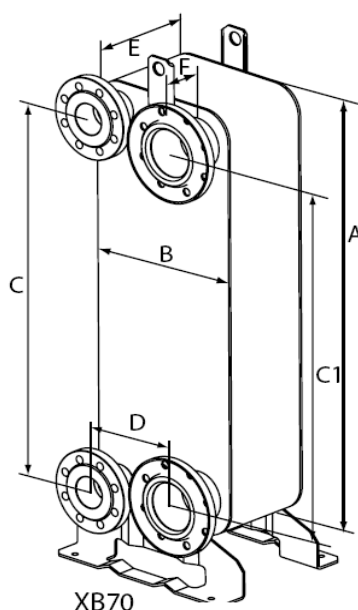

Prenosniki toplote

Koda	Tip	Masa [kg]	Dolž. (F+E+F) [mm]	Priključek		Cena EUR	
				vrsta	dimenzija		

Lotani prenosnik toplote z enim preходом XB, tip 12L-2

XB 12L-2

material plošč nerjaveče jeklo 1.4404, lotani z bakrom, PN25, primeren za obtočno in sanitarno vodo ter mešanice glikol/voda do 50% glikola, maks. temperatura medija 180°C, min. temperatura medija -10°C, pri temperaturah pod 2°C mora biti uporabljena mešanica glikola in vode.



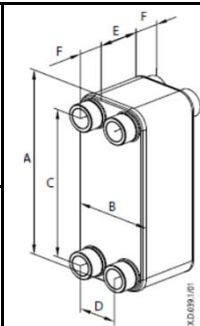

Dimenzije: horizontalna/vertikalna razdalja med priključki D/C=63/234mm, širina/višina B/A=118/289mm.

004H7572	XB 12L-2 20/20	5	120,0	zunanji cilindrični navoj ISO 228/1	G 1¼" A	379,00	
004H7573	© XB 12L-2 26/26	6	141,0			419,00	
004H7574	XB 12L-2 30/30	7	155,0			476,00	
004H7575	XB 12L-2 36/36	8	176,0			546,00	
004H7576	XB 12L-2 40/40	8	190,0			621,00	
004H7577	XB 12L-2 46/46	9	211,0			689,00	
004H7578	XB 12L-2 50/50	10	225,0			721,00	
004H7579	XB 12L-2 56/56	11	246,0			770,00	
004H7580	XB 12L-2 60/60	11	260,0			804,00	
004H7581	© XB 12L-2 66/66	12	281,0			845,00	
004H7582	© XB 12L-2 70/70	13	295,0			883,00	

Dodatki

Koda	Tip, opis	Cena EUR	
------	-----------	----------	--

Priključki

004B1358	© Set priključkov za lotanje G 1¼" A / 28mm, 2 priključka	42,00	
003H6910	Set varilnih priključkov G 1¼" A / DN25, 2 priključka	49,60	
004H4205	© Set navojnih priključkov G 1¼" A / G 1" A, 2 priključka	63,00	
004H4206	© Set navojnih priključkov G 1¼" A / G 1½" A, 2 priključka	74,00	

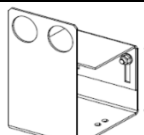

DN 32

Montažna konzola

004H4200	© Montažna konzola za XB 12	40,00	
----------	-----------------------------	-------	---

Izolacije

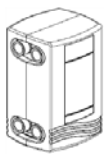
 $T_{maks}=130^{\circ}\text{C}$, kratkotrajno do 160°C

004H4211	PU izolacija za XB12L-2 : 20/20 -> 36/36	94,00	
004H4212	PU izolacija za XB12L-2 : 40/40 -> 50/50	97,00	
004H4213	PU izolacija za XB12L-2 : 56/56 -> 60/60	100,00	
004H4214	PU izolacija za XB12L-2 : 66/66 -> 70/70	102,00	
$T_{maks}=110^{\circ}\text{C}$			
004H4202	EPP izolacija za XB12L-2 : 20/20 -> 30/30	47,00	
004H4203	EPP izolacija za XB12L-2 : 36/36 -> 46/46	50,00	

Prenosniki toplote

Koda	Tip	Masa [kg]	Dolž. (F+E+F) [mm]	Priključek		Cena EUR	
				vrsta	dimenzija		

Lotani prenosnik toplote z enim prehodom XB, tip 12M-2

XB 12M-2

material plošč nerjaveče jeklo 1.4404, lotani z bakrom, PN25, primeren za obtočno in sanitarno vodo ter mešanice glikol/voda do 50% glikola, maks. temperatura medija 180°C, min. temperatura medija -10°C, pri temperaturah pod 2°C mora biti uporabljena mešanica glikola in vode.

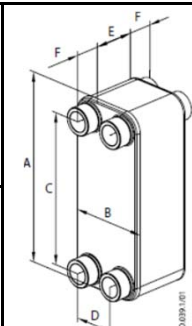

Dimenzije: horizontalna/vertikalna razdalja med priključki D/C=63/234mm, širina/višina B/A=118/289mm.

004H7584	XB 12M-2 20/20	5	106,0	zunanji cilindrični navoj ISO 228/1	G 1¼" A	379,00	
004H7585	© XB 12M-2 26/26	6	122,8			419,00	
004H7586	XB 12M-2 30/30	7	134,0			476,00	
004H7587	XB 12M-2 36/36	8	150,8			546,00	
004H7588	XB 12M-2 40/40	8	162,0			621,00	
004H7589	XB 12M-2 46/46	9	178,8			689,00	
004H7590	XB 12M-2 50/50	10	190,0			721,00	
004H7591	XB 12M-2 56/56	11	206,8			770,00	
004H7592	XB 12M-2 60/60	11	218,0			804,00	
004H7593	© XB 12M-2 66/66	12	234,8			845,00	
004H7594	© XB 12M-2 70/70	13	246,0			883,00	

Dodatki

Koda	Tip, opis	Cena EUR	
------	-----------	----------	--

Priključki

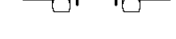
004B1358	© Set priključkov za lotanje G 1¼" A / 28mm, 2 priključka	42,00	
003H6910	Set varilnih priključkov G 1¼" A / DN25, 2 priključka	49,60	
004H4205	© Set navojnih priključkov G 1¼" A / G 1" A, 2 priključka	63,00	
004H4206	© Set navojnih priključkov G 1¼" A / G 1½" A, 2 priključka	74,00	

Montažna konzola

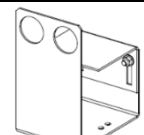
004H4200	© Montažna konzola za XB 12	40,00	
----------	-----------------------------	--------------	---

Izolacije

T_{maks}=130°C, kratkotrajno do 160°C

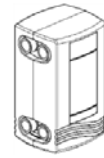
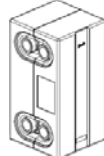
004H4210	PU izolacija za XB12M-2 : 20/20	90,00	
004H4211	PU izolacija za XB12M-2 : 26/26 -> 46/46	94,00	
004H4212	PU izolacija za XB12M-2 : 50/50 -> 66/66	97,00	
004H4213	PU izolacija za XB12M-2 : 70/70	100,00	
T _{maks} =110°C			
004H4201	EPP izolacija za XB12M-2 : 20/20	44,00	
004H4202	EPP izolacija za XB12M-2 : 26/26 -> 36/36	47,00	
004H4203	EPP izolacija za XB12M-2 : 40/40 -> 56/56	50,00	

Prenosniki toplote

Koda	Tip	Masa [kg]	Dolž. (F+E+F) [mm]	Priključek		Cena EUR
				vrsta	dimenzija	

Lotani prenosnik toplote z enim prehodom XB, tip 12H-2

XB 12H-2

material plošč nerjaveče jeklo 1.4404, lotani z bakrom, PN25, primeren za obtočno in sanitarno vodo ter mešanice glikol/voda do 50% glikola, maks. temperatura medija 180°C, min. temperatura medija -10°C, pri temperaturah pod 2°C mora biti uporabljena mešanica glikola in vode.

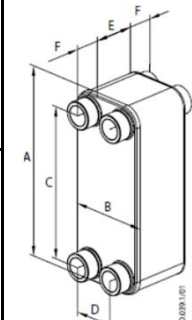

Dimenzije: horizontalna/vertikalna razdalja med priključki D/C=63/234mm, širina/višina B/A=118/289mm.

004H7596	© XB 12H-2 20/20	5	98,0	zunanji cilindrični navoj ISO 228/1	G 1¼" A	380,00	
004H7597	© XB 12H-2 26/26	6	112,4			419,00	
004H7598	XB 12H-2 30/30	7	122,0			476,00	
004H7599	XB 12H-2 36/36	8	136,4			546,00	
004H7600	XB 12H-2 40/40	8	146,0			621,00	
004H7601	XB 12H-2 46/46	9	160,4			689,00	
004H7602	XB 12H-2 50/50	10	170,0			721,00	
004H7603	XB 12H-2 56/56	11	184,4			770,00	
004H7604	XB 12H-2 60/60	11	194,0			804,00	
004H7605	XB 12H-2 66/66	12	208,4			845,00	
004H7606	© XB 12H-2 70/70	13	218,0			883,00	

Dodatki

Koda	Tip, opis	Cena EUR
------	-----------	----------

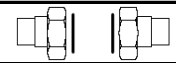
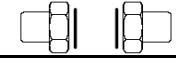
Priključki

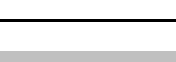
004B1358	© Set priključkov za lotanje G 1¼" A / 28mm, 2 priključka	42,00	
003H6910	Set varilnih priključkov G 1¼" A / DN25, 2 priključka	49,60	
004H4205	© Set navojnih priključkov G 1¼" A / G 1" A, 2 priključka	63,00	
004H4206	© Set navojnih priključkov G 1¼" A / G 1½" A, 2 priključka	74,00	

DN 32

Montažna konzola

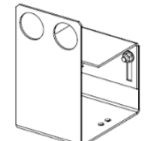
004H4200	© Montažna konzola za XB 12	40,00	
----------	-----------------------------	-------	---

Izolacije

 $T_{maks}=130^{\circ}\text{C}$, kratkotrajno do 160°C

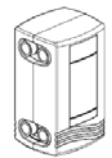
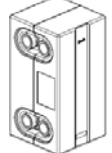
004H4210	PU izolacija za XB12H-2 : 20/20 -> 26/26	90,00	
004H4211	PU izolacija za XB12H-2 : 30/30 -> 50/50	94,00	
004H4212	PU izolacija za XB12H-2 : 56/56 -> 70/70	97,00	
$T_{maks}=110^{\circ}\text{C}$			
004H4201	EPP izolacija za XB12H-2 : 20/20	44,00	
004H4202	EPP izolacija za XB12H-2 : 26/26 -> 40/40	47,00	
004H4203	EPP izolacija za XB12H-2 : 46/46 -> 60/60	50,00	

Prenosniki toplote

Koda	Tip	Masa [kg]	Dolž. (F+E+F) [mm]	Priključek		Cena EUR	
				vrsta	dimenzija		

Lotani prenosnik toplote z dvema prehodoma XB, tip 51L-2

XB 51L-2

material plošč nerjaveče jeklo 1.4404, lotani z bakrom, PN25, primeren za obtočno in sanitarno vodo ter mešanice glikol/voda do 50% glikola, maks. temperatura medija 180°C, min. temperatura medija -10°C, pri temperaturah pod 0°C mora biti uporabljena mešanica glikola in vode.

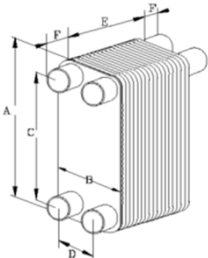

Dimenzije: horizontalna/vertikalna razdalja med priključki D/C=170/380mm, širina/višina B/A=253/462mm.

004B1147	© XB 51L-2 10/10	16	164	zunanj cilindrični navoj ISO 228/1	G 2" A	775,00	
004B1148	© XB 51L-2 16/16	21	195			1.002,00	
004B1149	© XB 51L-2 20/20	24	216			1.079,00	
004B1150	© XB 51L-2 26/26	28	247			1.255,00	
004B1293	© XB 51L-2 30/30	31	268			1.451,00	
004B1293	© XB 51L-2 36/36	36	299			1.451,00	
004B1294	© XB 51L-2 40/40	39	320			1.626,00	
004B1295	© XB 51L-2 46/46	43	351			1.774,00	
004B1296	© XB 51L-2 50/50	46	372			1.859,00	
004B1297	© XB 51L-2 56/56	51	403			1.988,00	
004B1298	© XB 51L-2 60/60	54	424	2.085,00			
004B1299	© XB 51L-2 66/66	59	455	2.213,00			
004B1300	© XB 51L-2 70/70	62	476	2.298,00			

Dodatki

Koda	Tip, opis	Cena EUR	
------	-----------	----------	--

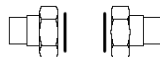
Priključki

004B2910	© Set priključkov za lotanje G 2" A / 28mm, 2 priključka	72,00	
004B2911	© Set priključkov za lotanje G 2" A / 35mm, 2 priključka	77,00	
004B2912	Set priključkov za lotanje G 2" A / 42mm, 2 priključka	74,00	
065B2006	Set varilnih priključkov G 2" A / DN 40, 2 priključka	88,60	

Montažna konzola

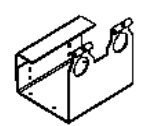
004H4518	© Montažna konzola za XB 51	72,00	
----------	-----------------------------	-------	---

Izolacije

T_{maks}=130°C, kratkotrajno do 160°C

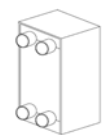
004B1935	Izolacija za XB51-2 : 30/30 -> 36/36	131,00	
004B1950	Izolacija za XB51-2 : 40/40 -> 50/50	141,00	
004B3735	Izolacija za XB51-2 : 55/56 -> 70/70	162,00	

Prenosniki toplote

Koda	Tip	Masa [kg]	Dolž. (F+E+F) [mm]	Priključek		Cena EUR	
				vrsta	dimenzija		

Lotani prenosnik toplote z dvema prehodoma XB, tip 52M-2

XB 52M-2

material plošč nerjaveče jeklo 1.4404, lotani z bakrom, PN25, primeren za obtočno in sanitarno vodo ter mešanice glikol/voda do 50% glikola, maks. temperatura medija 180°C, min. temperatura medija -10°C, pri temperaturah pod 0°C mora biti uporabljena mešanica glikola in vode.

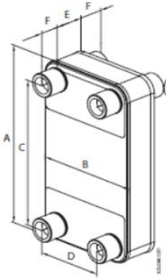

Dimenzije: horizontalna/vertikalna razdalja med priključki D/C=170/379mm, širina/višina B/A=256/466mm.

004H4540	XB 52M-2 20/20	19	188	zunanji cilindrični navoj ISO 228/1	G 2" A	1.079,00	
004H4541	XB 52M-2 26/26	23	209			1.255,00	
004H4542	XB 52M-2 30/30	25	223			1.330,00	
004H4543	XB 52M-2 36/36	28	244			1.451,00	
004H4544	XB 52M-2 40/40	30	258			1.626,00	
004H4545	XB 52M-2 46/46	33	279			1.774,00	
004H4546	XB 52M-2 50/50	36	293			1.859,00	
004H4547	XB 52M-2 56/56	39	314			1.988,00	
004H4548	XB 52M-2 60/60	41	328			2.085,00	
004H4549	XB 52M-2 66/66	44	349			2.213,00	
004H4550	XB 52M-2 70/70	46	363	2.298,00			

Dodatki

Koda	Tip, opis	Cena EUR	
------	-----------	----------	--

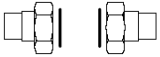
Priključki

004B2910	© Set priključkov za lotanje G 2" A / 28mm, 2 priključka	72,00	
004B2911	© Set priključkov za lotanje G 2" A / 35mm, 2 priključka	77,00	
004B2912	Set priključkov za lotanje G 2" A / 42mm, 2 priključka	74,00	
065B2006	Set varilnih priključkov G 2" A / DN 40, 2 priključka	88,60	

Montažna konzola

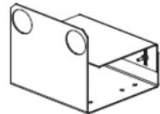
004H4518	© Montažna konzola za XB 52M	72,00	
----------	------------------------------	-------	---

Izolacije

T_{maks}=130°C, kratkotrajno do 160°C

004B1924	Izolacija za XB 52M-2 : 20/20 -> 36/36	118,00	
004B1935	Izolacija za XB 52M-2 : 40/40 -> 50/50	131,00	
004B1950	Izolacija za XB 52M-2 : 56/56 -> 70/70	141,00	

DN 50

Kazalo po kodah

Koda	Stran	Koda	Stran	Koda	Stran	Koda	Stran	Koda	Stran	Koda	Stran
003H6909	8	004B1534	14	004B1922	16	004B2009	23	004B2905	10	004B3447	18
003H6909	9	004B1536	14	004B1923	16	004B2010	23	004B2906	8	004B3448	18
003H6909	10	004B1651	16	004B1924	14	004B2011	23	004B2906	9	004B3449	18
003H6910	11	004B1652	16	004B1924	15	004B2012	24	004B2906	10	004B3450	18
003H6910	12	004B1653	16	004B1924	29	004B2013	24	004B2910	14	004B3451	18
003H6910	13	004B1654	16	004B1925	19	004B2014	24	004B2910	15	004B3452	19
003H6910	25	004B1655	17	004B1926	19	004B2015	24	004B2910	16	004B3453	19
003H6910	26	004B1655	18	004B1927	19	004B2016	24	004B2910	17	004B3454	19
003H6910	27	004B1655	19	004B1928	19	004B2017	24	004B2910	18	004B3455	19
004B1141	14	004B1656	17	004B1929	19	004B2018	24	004B2910	19	004B3456	19
004B1142	14	004B1656	18	004B1930	19	004B2019	24	004B2910	28	004B3457	19
004B1147	28	004B1656	19	004B1931	19	004B2020	24	004B2910	29	004B3458	19
004B1148	28	004B1657	17	004B1932	16	004B2024	5	004B2911	14	004B3459	19
004B1149	28	004B1657	18	004B1933	16	004B2025	5	004B2911	15	004B3542	20
004B1150	28	004B1657	19	004B1934	16	004B2026	5	004B2911	16	004B3542	21
004B1191	4	004B1658	17	004B1935	14	004B2027	5	004B2911	17	004B3543	20
004B1191	5	004B1658	18	004B1935	15	004B2028	5	004B2911	18	004B3543	21
004B1191	6	004B1721	8	004B1935	28	004B2029	5	004B2911	19	004B3544	20
004B1192	4	004B1721	9	004B1935	29	004B2030	5	004B2911	28	004B3545	20
004B1192	5	004B1721	10	004B1936	16	004B2031	5	004B2911	29	004B3545	21
004B1192	6	004B1722	8	004B1937	16	004B2032	5	004B2912	14	004B3546	20
004B1193	4	004B1722	9	004B1938	16	004B2033	5	004B2912	15	004B3546	21
004B1193	5	004B1722	10	004B1939	16	004B2034	5	004B2912	16	004B3556	3
004B1193	6	004B1723	8	004B1940	16	004B2036	6	004B2912	17	004B3557	3
004B1194	14	004B1723	9	004B1941	16	004B2037	6	004B2912	18	004B3558	3
004B1195	14	004B1723	10	004B1942	16	004B2038	6	004B2912	19	004B3559	3
004B1196	14	004B1725	8	004B1943	16	004B2039	6	004B2912	28	004B3560	3
004B1197	14	004B1725	9	004B1950	14	004B2041	6	004B2912	29	004B3561	3
004B1198	14	004B1725	10	004B1950	15	004B2042	6	004B2913	8	004B3562	3
004B1199	14	004B1726	8	004B1950	28	004B2043	6	004B2913	9	004B3563	3
004B1200	14	004B1726	9	004B1950	29	004B2044	6	004B2913	10	004B3564	3
004B1201	14	004B1727	8	004B1960	14	004B2046	6	004B2944	3	004B3565	3
004B1202	14	004B1728	8	004B1961	20	004B2047	6	004B2944	4	004B3735	14
004B1203	14	004B1728	9	004B1962	20	004B2048	6	004B2944	5	004B3735	28
004B1204	14	004B1728	10	004B1963	20	004B2425	22	004B2944	6	004H4200	11
004B1206	4	004B1788	17	004B1964	20	004B2430	22	004B2945	3	004H4200	12
004B1207	4	004B1788	18	004B1965	20	004B2435	22	004B2945	4	004H4200	13
004B1209	4	004B1788	19	004B1966	20	004B2440	22	004B2945	5	004H4200	25
004B1211	4	004B1788	20	004B1967	20	004B2445	22	004B2945	6	004H4200	26
004B1212	4	004B1788	21	004B1968	20	004B2450	22	004B2946	3	004H4200	27
004B1214	4	004B1789	17	004B1969	20	004B2455	22	004B2946	4	004H4201	11
004B1216	4	004B1789	18	004B1970	20	004B2460	22	004B2946	5	004H4201	12
004B1217	4	004B1789	19	004B1971	20	004B2470	22	004B2946	6	004H4201	13
004B1219	4	004B1789	20	004B1987	21	004B2480	22	004B2947	3	004H4201	26
004B1221	4	004B1789	21	004B1988	21	004B2490	22	004B2947	4	004H4201	27
004B1222	4	004B1790	17	004B1989	21	004B2499	22	004B2947	5	004H4202	11
004B1223	4	004B1790	18	004B1990	21	004B2535	22	004B2947	6	004H4202	12
004B1245	16	004B1790	19	004B1991	21	004B2535	23	004B2948	4	004H4202	13
004B1293	28	004B1790	20	004B1992	21	004B2535	24	004B2948	5	004H4202	25
004B1293	28	004B1906	17	004B1993	21	004B2550	22	004B2948	6	004H4202	26
004B1294	28	004B1907	17	004B1994	21	004B2550	23	004B2953	3	004H4202	27
004B1295	28	004B1908	17	004B1995	21	004B2550	24	004B2953	4	004H4203	11
004B1296	28	004B1909	17	004B1996	21	004B2570	22	004B2953	5	004H4203	12
004B1297	28	004B1910	17	004B1997	21	004B2570	23	004B2953	6	004H4203	13
004B1298	28	004B1911	17	004B1998	21	004B2570	24	004B3436	17	004H4203	25
004B1299	28	004B1912	17	004B1999	21	004B2599	22	004B3437	17	004H4203	26
004B1300	28	004B1913	18	004B2000	23	004B2599	23	004B3438	17	004H4203	27
004B1358	11	004B1914	18	004B2001	23	004B2901	8	004B3439	17	004H4205	11
004B1358	12	004B1915	18	004B2002	23	004B2901	9	004B3440	17	004H4205	12
004B1358	13	004B1916	18	004B2003	23	004B2901	10	004B3441	17	004H4205	13
004B1358	25	004B1917	18	004B2004	23	004B2904	8	004B3442	17	004H4205	25
004B1358	26	004B1918	18	004B2005	23	004B2904	9	004B3443	17	004H4205	26
004B1358	27	004B1919	18	004B2006	23	004B2904	10	004B3444	18	004H4205	27
004B1532	14	004B1920	16	004B2007	23	004B2905	8	004B3445	18	004H4206	11
004B1533	14	004B1921	16	004B2008	23	004B2905	9	004B3446	18	004H4206	12

Kazalo po kodah

Koda	Stran	Koda	Stran	Koda	Stran	Koda	Stran	Koda	Stran	Koda	Stran
004H4206	13	004H7280	8	004H7557	13						
004H4206	25	004H7281	8	004H7558	13						
004H4206	26	004H7282	8	004H7559	13						
004H4206	27	004H7283	8	004H7560	13						
004H4210	11	004H7284	8	004H7561	13						
004H4210	12	004H7285	9	004H7562	13						
004H4210	13	004H7286	9	004H7563	13						
004H4210	26	004H7287	9	004H7564	13						
004H4210	27	004H7288	9	004H7565	13						
004H4211	11	004H7289	9	004H7566	13						
004H4211	12	004H7290	9	004H7567	13						
004H4211	13	004H7291	9	004H7568	13						
004H4211	25	004H7292	9	004H7569	13						
004H4211	26	004H7293	9	004H7570	13						
004H4211	27	004H7294	9	004H7572	25						
004H4212	11	004H7295	9	004H7573	25						
004H4212	12	004H7296	9	004H7574	25						
004H4212	13	004H7297	9	004H7575	25						
004H4212	25	004H7298	9	004H7576	25						
004H4212	26	004H7299	9	004H7577	25						
004H4212	27	004H7300	10	004H7578	25						
004H4213	11	004H7301	10	004H7579	25						
004H4213	25	004H7302	10	004H7580	25						
004H4213	26	004H7303	10	004H7581	25						
004H4214	25	004H7304	10	004H7582	25						
004H4518	14	004H7305	10	004H7584	26						
004H4518	15	004H7306	10	004H7585	26						
004H4518	28	004H7307	10	004H7586	26						
004H4518	29	004H7308	10	004H7587	26						
004H4520	15	004H7309	10	004H7588	26						
004H4521	15	004H7310	10	004H7589	26						
004H4522	15	004H7311	10	004H7590	26						
004H4523	15	004H7312	10	004H7591	26						
004H4524	15	004H7313	10	004H7592	26						
004H4525	15	004H7314	10	004H7593	26						
004H4526	15	004H7525	11	004H7594	26						
004H4527	15	004H7526	11	004H7596	27						
004H4528	15	004H7527	11	004H7597	27						
004H4529	15	004H7528	11	004H7598	27						
004H4530	15	004H7529	11	004H7599	27						
004H4531	15	004H7530	11	004H7600	27						
004H4532	15	004H7531	11	004H7601	27						
004H4533	15	004H7532	11	004H7602	27						
004H4534	15	004H7533	11	004H7603	27						
004H4540	29	004H7534	11	004H7604	27						
004H4541	29	004H7535	11	004H7605	27						
004H4542	29	004H7536	11	004H7606	27						
004H4543	29	004H7537	11	065B2006	14						
004H4544	29	004H7538	11	065B2006	15						
004H4545	29	004H7540	12	065B2006	16						
004H4546	29	004H7541	12	065B2006	17						
004H4547	29	004H7542	12	065B2006	18						
004H4548	29	004H7543	12	065B2006	19						
004H4549	29	004H7544	12	065B2006	28						
004H4550	29	004H7545	12	065B2006	29						
004H7270	8	004H7546	12								
004H7271	8	004H7547	12								
004H7272	8	004H7548	12								
004H7273	8	004H7549	12								
004H7274	8	004H7550	12								
004H7275	8	004H7551	12								
004H7276	8	004H7552	12								
004H7277	8	004H7553	12								
004H7278	8	004H7555	13								
004H7279	8	004H7556	13								

